

CODE NUMBER

24501411

DESCRIPTION

ST-2459 Water Closet and ECOS 111 Flushometer.

COMPONENTS

- Flushometer: Code 3370421
- Water Closet: Code 2102459

DETAILS

- Flush Volume: 1.28 gpf (4.8 Lpf)
- Nominal Dimensions: 26 ¾" x 15" x 13 ¼" (679 x 381 x 337mm)

FLUSHOMETER FEATURES

- Includes standard 18" electrical cable
- User friendly three (3) second Flush Delay
- Sweat solder adapter with cover tube and cast wall flange with set screw
- Infrared Sensor with Multiple-focused, Lobular Sensing Fields for high and low target detection
- Fixed Metering Bypass and No External Volume Adjustment to Ensure Water Conservation
- Flex Tube Diaphragm designed for improved life and reduced maintenance
- Engineered Metal Cover with replaceable Lens Window
- Line Powered with 6 VAC Step Down Transformer
- Free Spinning, Vandal Resistant Stop Cap
- ADA Compliant Sloan ECOS® Electronic Line Powered Infrared Sensor for automatic "No Hands" operation
- 1" I.P.S. Screwdriver Bak-Chek® Angle Stop
- Courtesy Flush® Override Button
- High Chloramine Resistant PERMEX® Synthetic Rubber DFB Dual Filtered Bypass Diaphragm
- Diaphragm, Stop Seat and Vacuum Breaker to be molded from PERMEX® rubber compound for Chloramine resistance

FIXTURE FEATURES

- White Vitreous China
- Elongated bowl
- Wall mounted, wall outlet
- Siphon jet flushing action achieves 1000g Map score when used with any Sloan flushometer
- Static load rating of 750 lbs (see Notes)
- Water spot area: 10½" x 9¾" (26 cm x 24 cm)
- 1½" I.P.S. top spud inlet
- 2½" fully glazed trapway
- Closet bolts and caps included
- Toilet seat not included
- Static load rating of 750 lbs. (See Notes)



COMPLIANCES & CERTIFICATIONS



(BREEAM Water Credit, Green Globes Water Credit, LEED V4 Water Efficiency Credit, Satisfies LEED Credits, WaterSense Listed, BAA Compliant)

DOWNLOADS

- [SS/ST/SU/WETS/WEUS Fixtures Repair and Maintenance Guide](#)
- [Additional Downloads](#)

NOTES

All information contained within this document subject to change without notice.

Static load tested according to the procedure outlined in Section 6.7 of ASME A112.19.2. Not recommended for bariatric use.

Sloan 10500 Seymour Ave, Franklin Park, IL 60131

Phone: 800.982.5839 • Fax: 800.447.8329 • sloan.com

ROUGH-IN

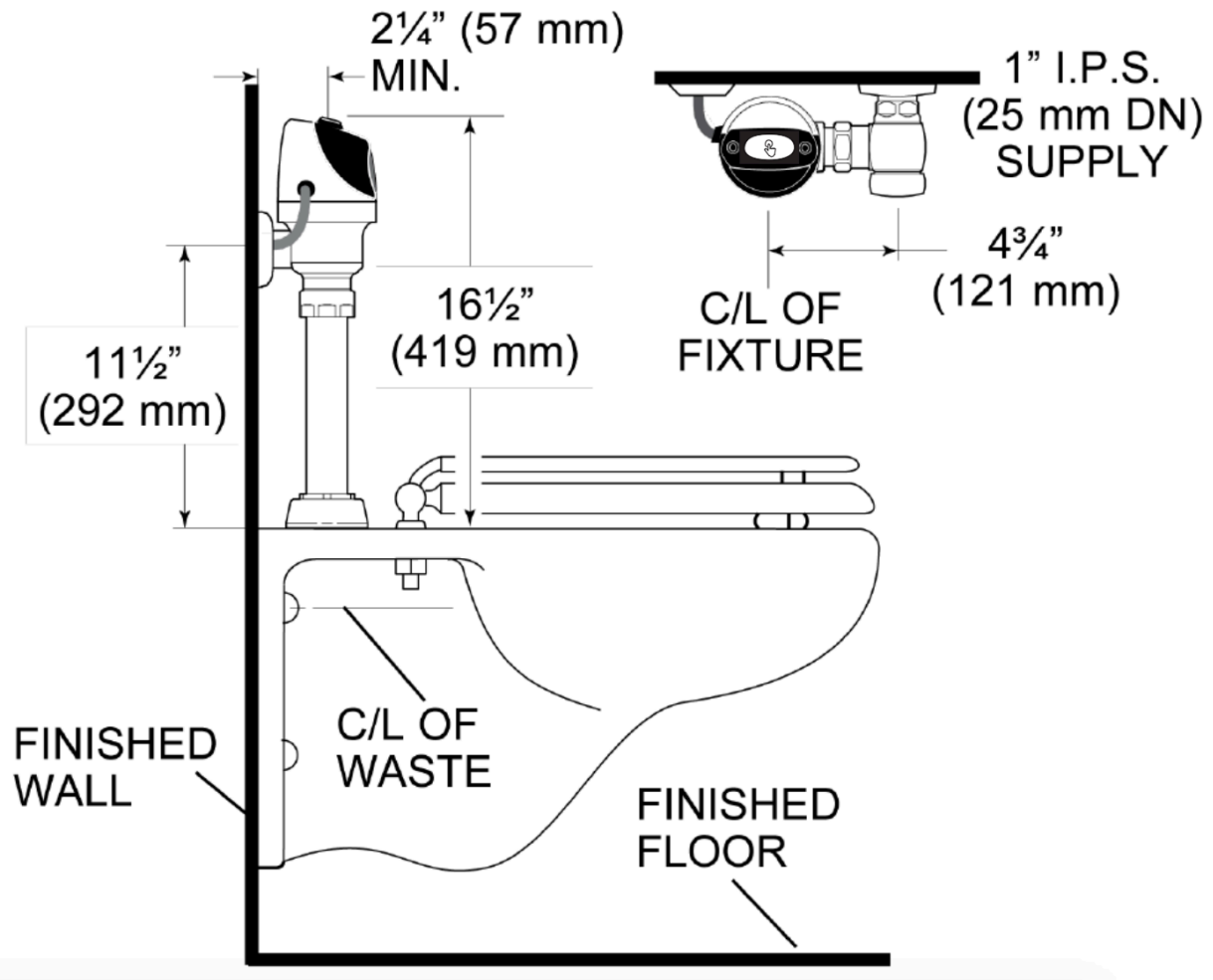

Sloan 10500 Seymour Ave, Franklin Park, IL 60131
 Phone: 800.982.5839 • Fax: 800.447.8329 • sloan.com